

PTMC210204MD

Wideband LDMOS Two-stage Integrated Power Amplifier 20 W, 28 V, 1805 – 2200 MHz

Description

The PTMC210204MD is a wideband, two-stage, LDMOS integrated power amplifier. It incorporates internal matching for operation from 1805 MHz to 2200 MHz, and dual independent outputs with 10 W of output power each. It is available in an 14-lead plastic overmold package with gull wing leads.

PTMC210204MD
Package PG-HB1DSO-14-1
(formed leads)

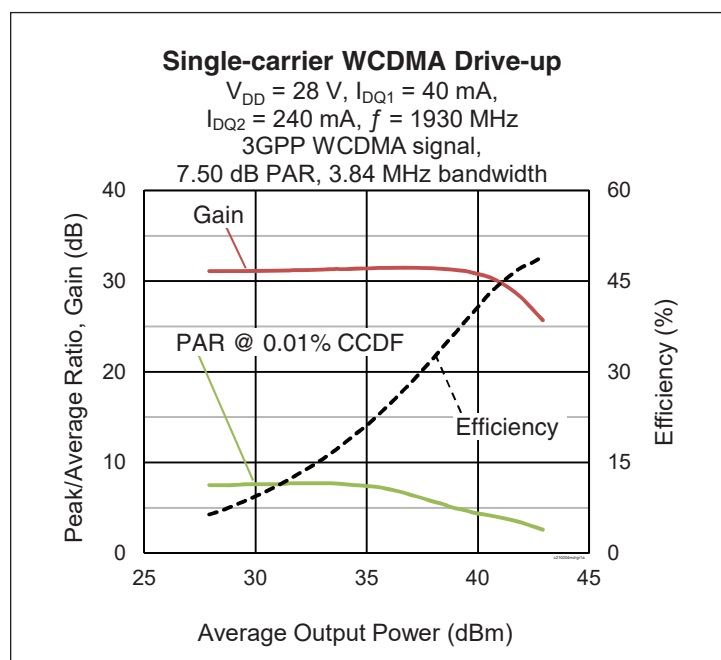
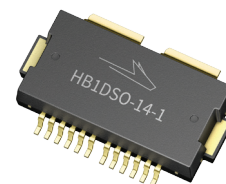

Features

- On-chip matching for broadband operation
- Typical pulsed CW performance, 1990 MHz, 28 V, combined outputs
 - Output power at $P_{1dB} = 20.9\text{ W}$
 - Efficiency = 56%
 - Gain = 31 dB
- Capable of handling 10:1 VSWR @ 28 V, 20.9 W (CW) output power
- Integrated ESD protection
- Human Body Model Class 1A (per ANSI/ESDA/ JEDEC JS-001)
- Integrated temperature compensation
- Pb-free and RoHS compliant

RF Characteristics

Single-carrier WCDMA Specifications (tested in Wolfspeed test fixture)

$V_{DD} = 28\text{ V}$, $I_{DQ1(A+B)} = 20\text{ mA}$, $I_{DQ2(A+B)} = 120\text{ mA}$, $P_{OUT} = 2.5\text{ W avg}$, $f = 1990\text{ MHz}$, 3GPP WCDMA signal, channel bandwidth = 3.84 MHz, peak/average = 7.5 dB @ 0.01% CCDF

Characteristic	Symbol	Min	Typ	Max	Unit
Linear Gain	G_{ps}	28.5	30.5	33.5	dB
Power Added Efficiency	PAE	17	19	—	%
Adjacent Channel Power Ratio	ACPR	—	-47	-40	dBc

All published data at $T_{CASE} = 25^\circ\text{C}$ unless otherwise indicated

ESD: Electrostatic discharge sensitive device—observe handling precautions!

DC Characteristics

Stage 1	Conditions	Symbol	Min	Typ	Max	Unit
Drain Leakage Current	$V_{DS} = 28\text{ V}, V_{GS} = 0\text{ V}$	I_{DSS}	—	—	0.1	μA
	$V_{DS} = 60\text{ V}, V_{GS} = 0\text{ V}$	I_{DSS}	—	—	1.0	μA
Gate Leakage Current	$V_{GS} = 1\text{ V}, V_{DS} = 0\text{ V}$	I_{GSS}	—	—	0.1	μA
On-state Resistance	$V_{GS} = 10\text{ V}, V_{DS} = 0.1\text{ V}$	$R_{DS(on)}$	—	8	—	Ω
Operating Gate Voltage	$V_{DS} = 28\text{ V}, I_{DQ1} = 20\text{ mA}$	V_{GS1}	—	2.7	—	V
Fixture Operating Gate Voltage	$V_{DS} = 28\text{ V}, I_{DQ1} = 20\text{ mA}$	V_{GS1}	—	4.52	—	V

Stage 2	Conditions	Symbol	Min	Typ	Max	Unit
Drain-source Breakdown Voltage	$V_{GS} = 0\text{ V}, I_{DS} = 10\text{ mA}$	$V_{BR(DSS)}$	65	—	—	V
Drain Leakage Current	$V_{DS} = 28\text{ V}, V_{GS} = 0\text{ V}$	I_{DSS}	—	—	0.1	μA
	$V_{DS} = 60\text{ V}, V_{GS} = 0\text{ V}$	I_{DSS}	—	—	1.0	μA
Gate Leakage Current	$V_{GS} = 1\text{ V}, V_{DS} = 0\text{ V}$	I_{GSS}	—	—	0.1	μA
On-state Resistance	$V_{GS} = 10\text{ V}, V_{DS} = 0.1\text{ V}$	$R_{DS(on)}$	—	0.9	—	Ω
Operating Gate Voltage	$V_{DS} = 28\text{ V}, I_{DQ2} = 120\text{ mA}$	V_{GS2}	—	2.72	—	V
Fixture Opererating Gate Voltage	$V_{DS} = 28\text{ V}, I_{DQ2} = 120\text{ mA}$	V_{GS2}	—	4.74	—	V

Maximum Ratings

Parameter	Symbol	Value	Unit
Drain-Source Voltage	V_{DSS}	65	V
Gate-Source Voltage	V_{GS}	-6 to +12	V
Junction Temperature	T_J	225	$^{\circ}\text{C}$
Storage Temperature Range	T_{STG}	-65 to +150	$^{\circ}\text{C}$
Operating Voltage	V_{DD}	0 to 32	V

Thermal Characteristics

Characteristic	Symbol	Value	Unit		
Thermal Resistance	Stage 1	($T_{CASE} = 70^{\circ}\text{C}, 10\text{ W CW}$)	$R_{\theta JC}$	9.7	$^{\circ}\text{C/W}$
	Stage 2	($T_{CASE} = 70^{\circ}\text{C}, 10\text{ W CW}$)	$R_{\theta JC}$	3.1	$^{\circ}\text{C/W}$

Moisture Sensitivity Level

Level	Test Standard	Package Temperature	Unit
3	IPC/JEDEC J-STD-020	260	$^{\circ}\text{C}$



Ordering Information

Type and Version	Order Code	Package and Description	Shipping
PTMC210204MD V1 R5	PTMC210204MD-V1-R5	PG-HB1DSO-14-1, 14-lead, overmold	Tape & Reel, 500 pcs

Evaluation Boards

Order Code	Frequency	Description
LTN/PTMC210204MD V1	1930 – 1990 MHz	Class AB with combined outputs, R04360, 0.508 mm thick
LTN/PTMC210204MD E2	1805 – 1880 MHz	Class AB with combined outputs, R04360, 0.508 mm thick
LTN/PTMC210204MD E3	2110 – 2200 MHz	Class AB with combined outputs, R04360, 0.508 mm thick

Find Gerber files for these reference fixtures on the Wolfspeed Web site at www.wolfspeed.com/RF

Typical RF Performance (data taken in production test fixture)

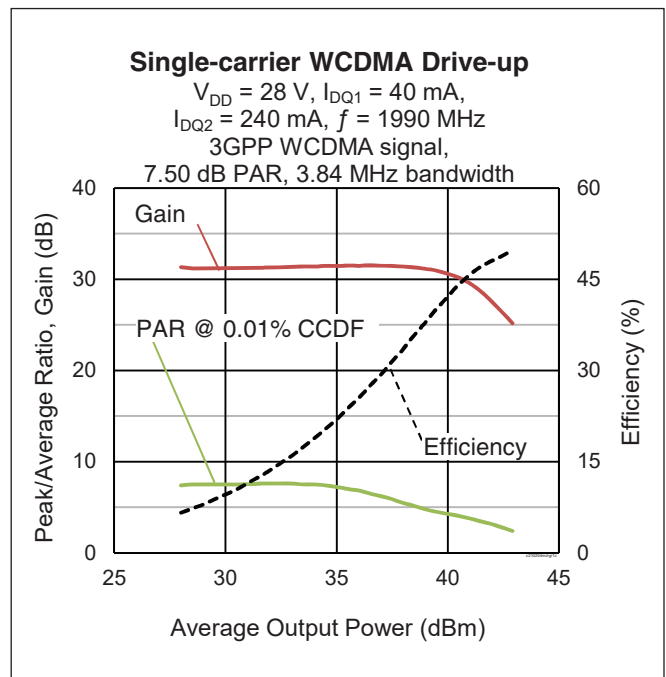
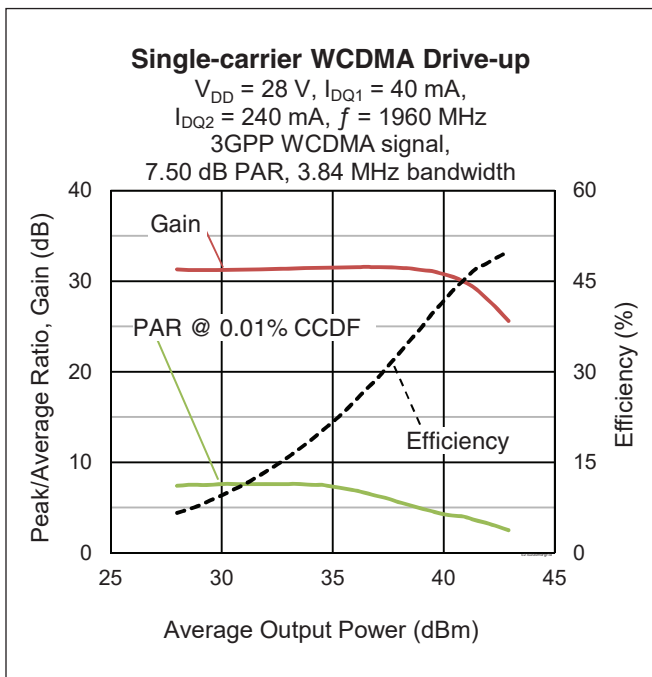

Typical Performance (cont.)

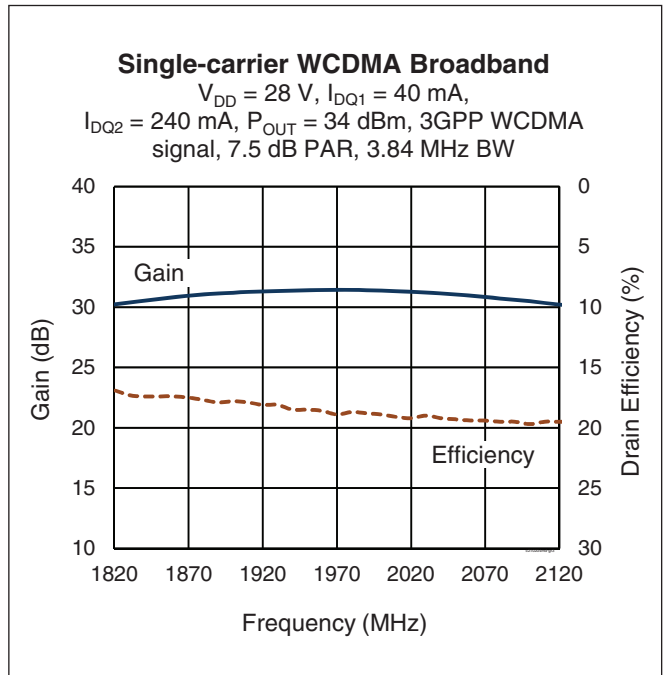
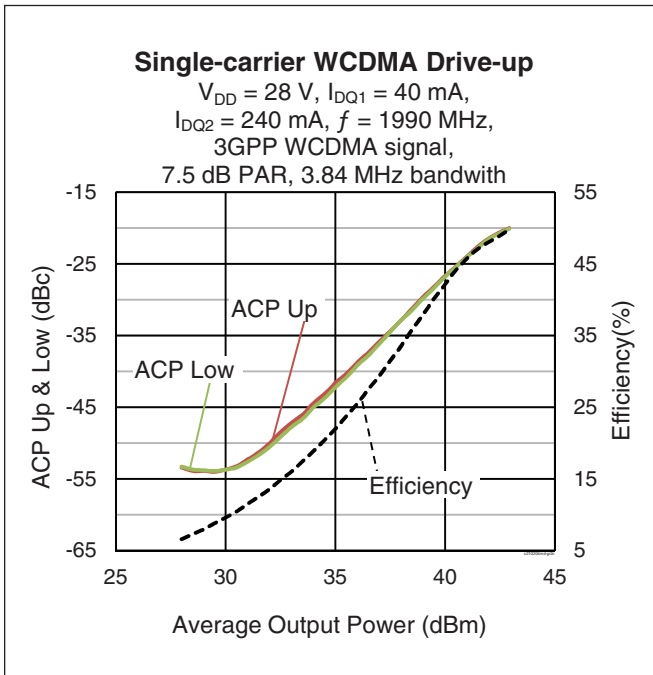
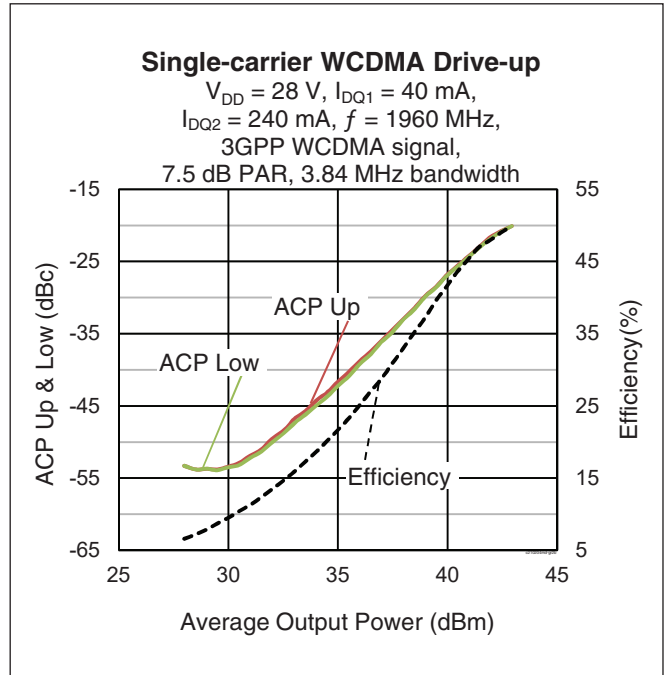
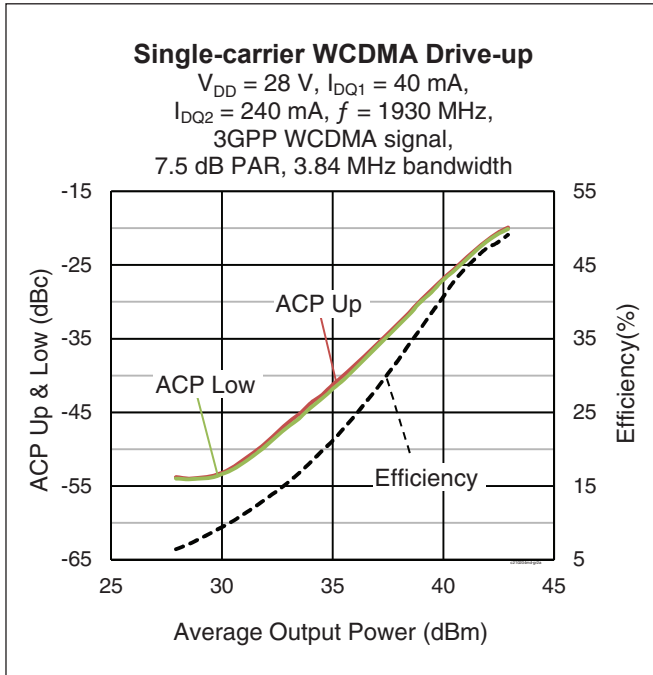

Typical Performance (cont.)

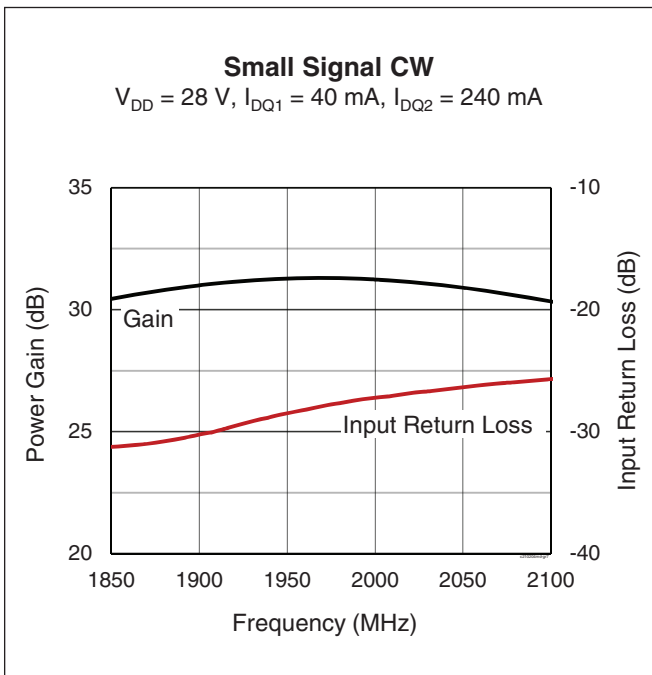
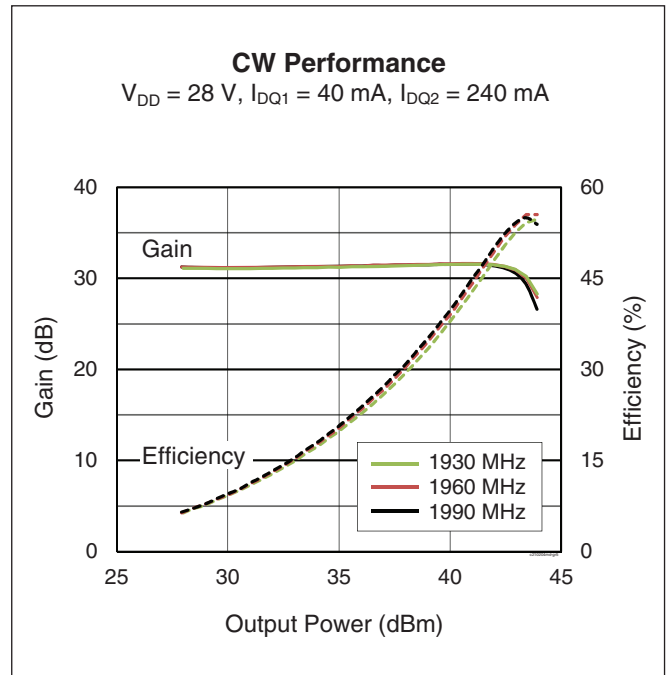
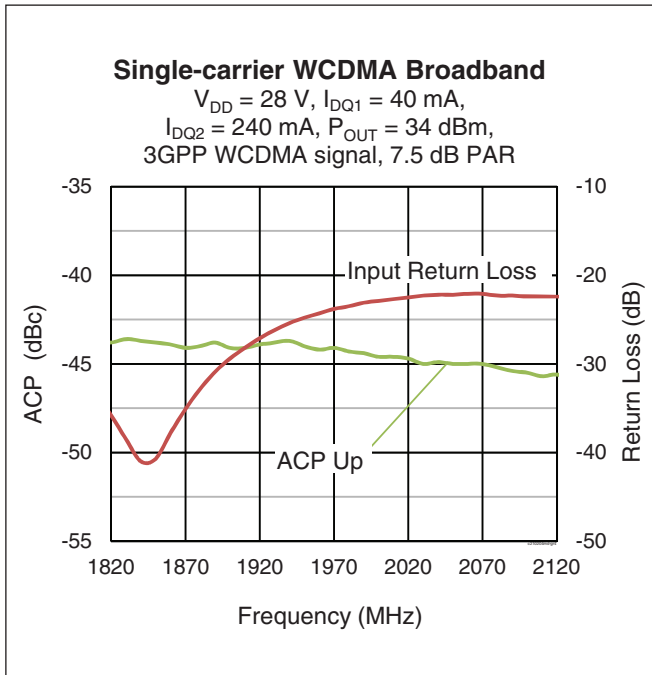



Load Pull

CW signal: $V_{DD1} = V_{DD2} = 28\text{ V}$, $I_{DQ1} = 20\text{ mA}$, $I_{DQ2} = 120\text{ mA}$

Class AB		P_{1dB}					P_{1dB}				
		Max Output Power					Max PAE				
Freq [MHz]	Zs [Ω]	Zl [Ω]	Gain [dB]	P _{OUT} [dBm]	P _{OUT} [W]	PAE [%]	Zl [Ω]	Gain [dB]	P _{OUT} [dBm]	P _{OUT} [W]	PAE [%]
1930	30.5 - j12.8	15.40 - j8.85	29.92	41.07	12.79	51.47	18.01 + j1.18	31.45	39.94	9.86	57.02
1960	30.5 - j12.8	14.58 - j7.65	29.97	41.09	12.85	52.17	17.16 + j0.14	31.26	40.16	10.38	57.35
1990	30.5 - j12.8	15.26 - j9.82	29.61	41.06	12.76	50.58	16.16 + j0.97	31.25	39.88	9.73	57.30

Reference Circuit, tuned for 1930 – 1990 MHz

DUT	PTMC210204MD V1
Test Fixture Part No.	LTN/PTMC210204MD V1
PCB	Rogers 4350, 0.508 mm [.020"] thick, 2 oz. copper, $\epsilon_r = 3.66$

Find Gerber files for this reference fixture on the Wolfspeed Web site at www.wolfspeed.com/RF

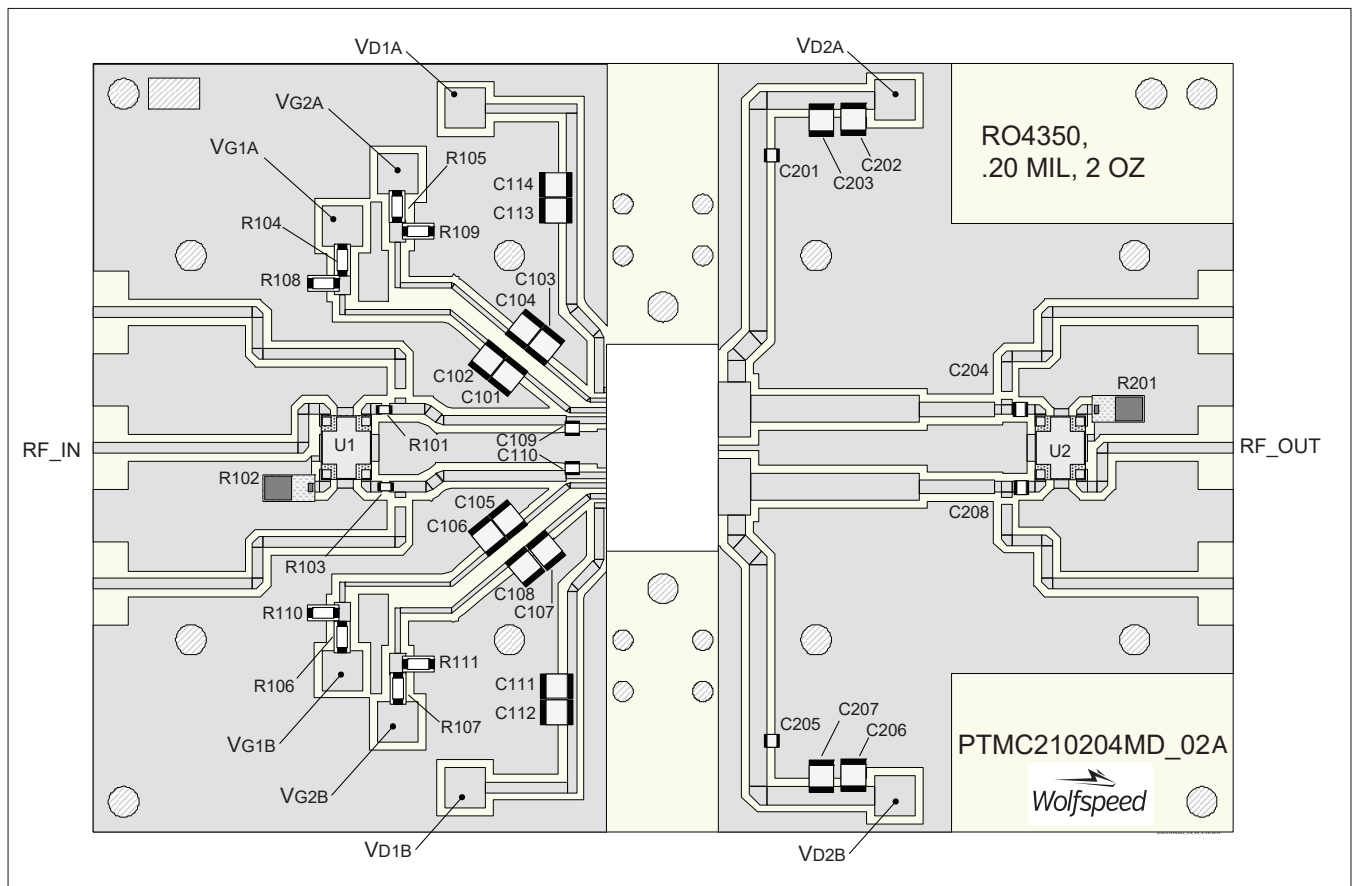

Reference circuit assembly diagram (not to scale)

Reference Circuit (cont.)

Component Information

Component	Description	Manufacturer	P/N
Input			
C101, C103, C105, C107, C111, C113, C203, C207	Capacitor, 4.7 μ F	Murata Electronics North America	GRM32ER71H475KA88L
C102, C104, C106, C108, C112, C114, C202, C206	Capacitor, 10 μ F	Taiyo Yuden	UMK325C7106MM-T
C109, C110	Capacitor, 0.8 pF	ATC	ATC800A0R8CT250T
C201, C204, C205, C208	Capacitor, 10 pF	ATC	ATC800A100JT250T
R101, R103	Resistor, 0.0 ohms	Panasonic Electronic Components	ERJ-3GEY0R00V
R102, R201	Resistor, 50 ohms	Anaren	C8A50Z4A
R104, R105, R106, R107	Resistor, 1K ohms	Panasonic Electronic Components	ERJ-8GEYJ102V
R108, R109, R110, R111	Resistor, 4.3K ohms	Panasonic Electronic Components	ERJ-8GEYJ432V
U1, U2	Hybrid Coupler	Anaren	X3C19P1-03S

Pinout Diagram

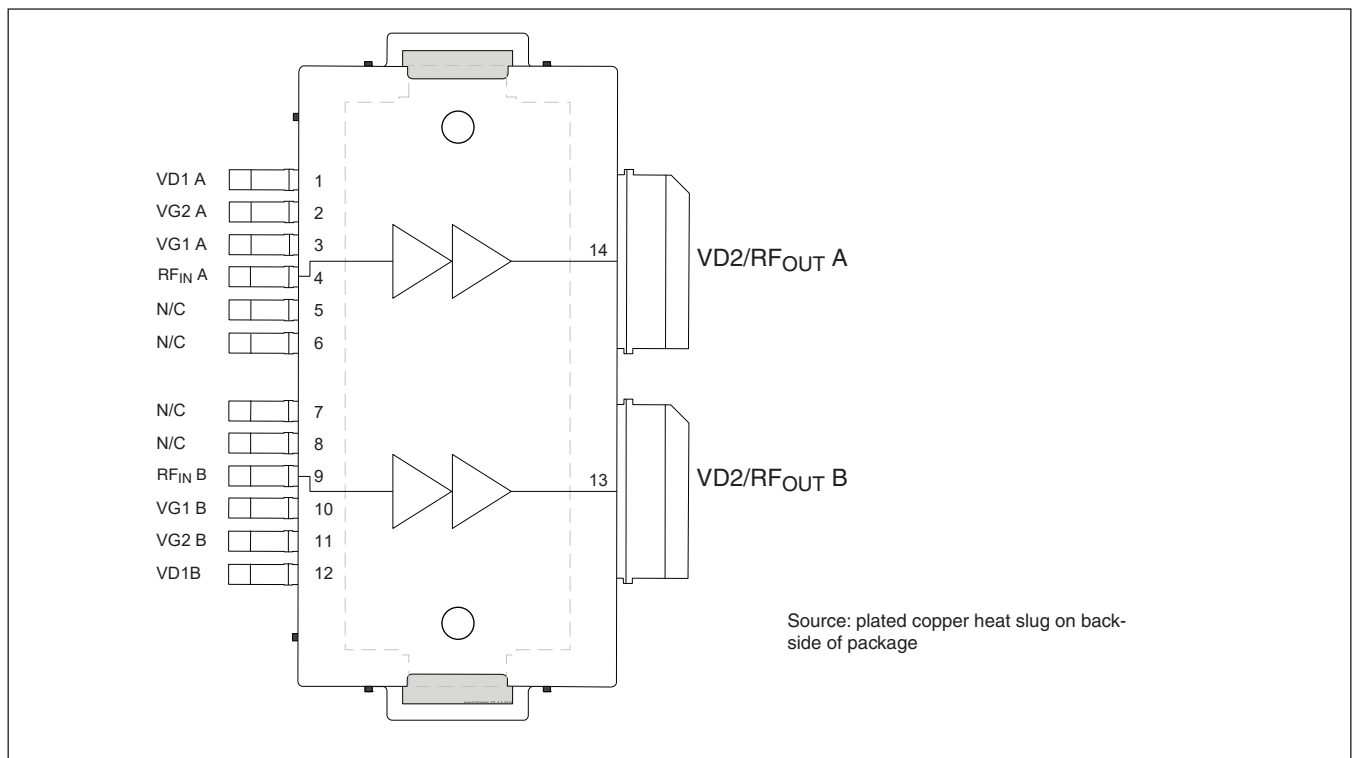

Package Outline Specifications

Package PG-HB1DSO-14-1
(formed leads)

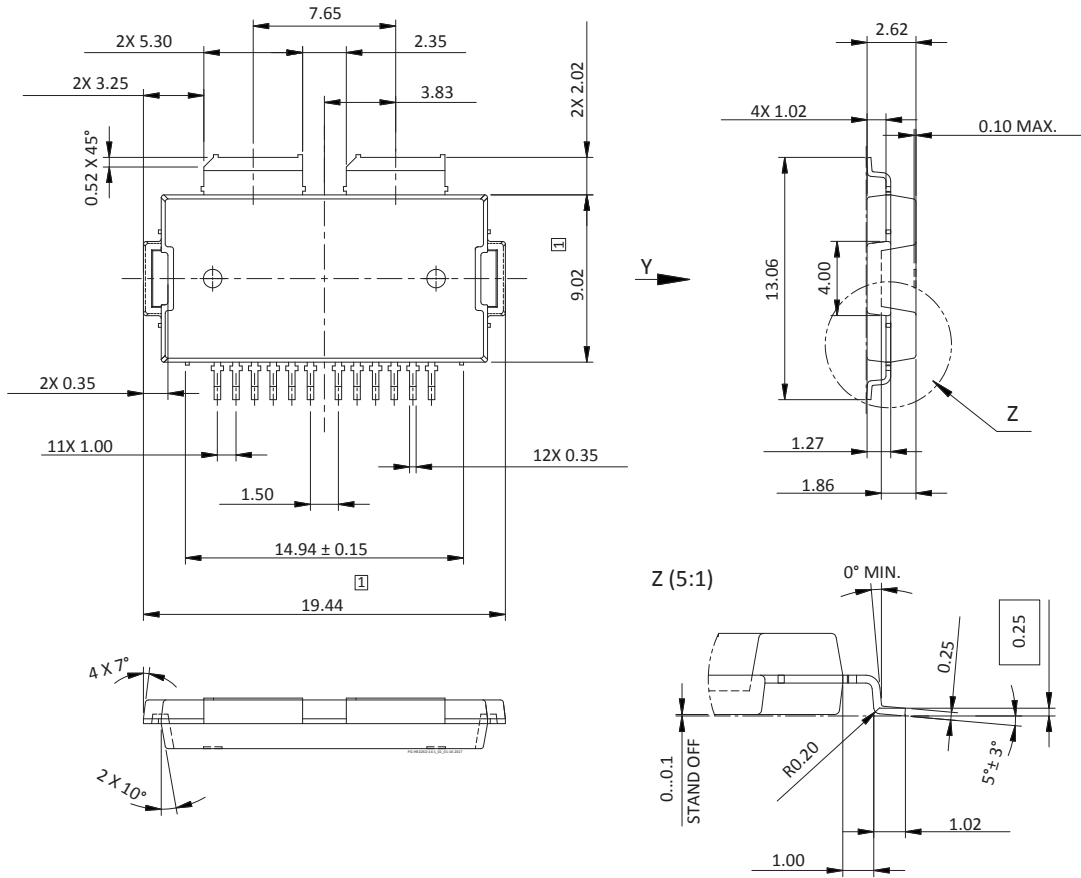

Diagram Notes—unless otherwise specified:

1. Mold/dam bar/metal protrusion of 0.30 mm max per side not included.
2. Metal protrusions are connected to source and shall not exceed 0.10 mm max.
3. Fillets and radii: all radii are 0.30 mm max.
4. Interpret dimensions and tolerances per ISO 8015.
5. Dimensions are mm.
- 6 All tolerances ± 0.1 mm unless specified otherwise.
7. All metal surfaces pre-plated, except area of cut.
8. Lead thickness: 0.25 mm.
9. Gold plating thickness: 0.25 micron max.

